

EPsolar

# **eTracer-BND Series**

— **Maximum Power Point Tracking**

**Solar Charge Controller**

# **OPERATION MANUAL**

Thank you very much for selecting our product!

This manual offers important information and suggestion about installation, use and troubleshooting, etc. Please read this manual carefully before using the product and pay attention to the safety recommendations in it.



# eTracer-BND Series

—— Maximum Power Point Tracking  
Solar Charge Controller



Models:

*ET4415BND/ET6415BND*

Final interpretation right of the manual belongs to EPsolar.  
Any changes without prior notice!

# Contents

1 Important Safety Information.....	1
2 General Information.....	2
2.1 Overview.....	2
2.2 Models & Parameters.....	3
2.3 Characteristics.....	4
2.4 Accessories.....	6
3 Installation Instructions.....	7
3.1 General Installation Notes.....	7
3.2 Mounting.....	8
3.3 Wiring.....	9
4 Operation.....	13
4.1 MPPT Technology.....	13
4.2 Battery Charging Information.....	15
4.3 LED Indication.....	17
4.4 LCD Display & Operation.....	18
5 Protections, Troubleshooting & Maintenance.....	25
5.1 Protections.....	25
5.2 Troubleshooting.....	25
5.3 Maintenance.....	26
6 PC Software.....	28
7 Warranty.....	30
8 Specifications.....	31
9 Conversion Efficiency Curves.....	33
10 Dimensions.....	37

# 1 Important Safety Information

This manual contains important safety, installation and operating instructions for the eTracer-BND Series MPPT solar controller. Save these instructions.

The following symbols are used throughout this manual to indicate potentially dangerous conditions or mark important safety instructions.



**WARNING:** Indicates a potentially dangerous condition. Use extreme caution when performing this task.



**CAUTION:** Indicates a critical procedure for safe and proper operation of the controller.



**NOTE:** Indicates a procedure or function that is important for safe and proper operation of the controller.

## General Safety Information

---

- Read all of the instructions and cautions in the manual before installation.
- There are no user serviceable parts inside the controller. Do not disassemble or attempt to repair the controller.
- Mount the controller indoors. Prevent exposure to the elements and do not allow water to enter the controller.
- Install eTracer-BND controller in well ventilated places, the heat sink of controller may become very hot during operation.
- Install external fuses/breakers as required.
- Disconnect the solar module and fuse/breakers near to battery before installing or adjusting the controller.
- Power connections must remain tight to avoid excessive heating from a loose connection.

## 2 General Information

### 2.1 Overview

---

Thank you for selecting the eTracer-BND Series MPPT solar controller. The controller is a high-end industrial class product based on multiphase synchronous rectification technology and has the features of high efficiency and reliability. The features are listed below:

- 12/24/36/48VDC system voltage automatic recognition or user-defined working voltage
- Smart tracking algorithm that finds and maintains operation at the solar array peak power point with the tracking efficiency as high as 99.7%
- Multiphase synchronous rectification technology ensures peak conversion efficiency is up to 98.7%
- High effective conversion efficiency at small power charging with multiphase power decentralized control and improves the generated energy
- Double processors architecture with high speed and performance improves the response speed and optimizes the performance of the system
- Multiphase control technology, optimizes charging current smoothness, reduces ripple and improves the system generating efficiency
- Excellent EMC design
- Excellent heat dissipation. Using the integration of cast aluminum radiator shell, the controller can be natural cooling
- 128\*64 dot-matrix LCD intuitively displays data and state, 6 buttons combinations for easy operation
- RS-232, RS-485 ports via the open standard Modbus protocol are supported to meet different occasion of demand
- Support 4 charging preprogram options: Sealed, Gel, Flooded and User-defined
- Protection: Over temperature, over charging, PV (battery) reversed, PV reverse current protect at night, over current protection
- Actual Power Display and record function make convenience to check the datum every day, every month and every year
- Log function: work logs and alarm logs are all recorded
- Firmware update: convenience to after-service and maintenance service

The controller features a built-in fuzzy control algorithm that maximizes the energy from the solar module(s) and charge the battery.

The battery charging process has been optimized for long battery life and improved system performance. The comprehensive self-diagnostics and electronic protection functions can prevent damage from installation mistakes or system faults.

Please take the time to read this operation's manual and become familiar with the controller. This will help you make full use of all the functions and improve your PV system.

## 2.2 Models & Parameters

---

Maximum 150 Volt dc systems\*\*

RS-232, RS-485 port

ET4415BND

.....

- ✓ Rated charge current 45A
- ✓ PV input Max. Power 2400W
- ✓ 12V/24V/36V/48V system voltage and auto work \*

ET6415BND

.....

- ✓ Rated charge current 60A
- ✓ PV input Max. Power 3200W
- ✓ 12V/24V/36V/48V system voltage and auto work \*

*\* The “auto work” setting allows the controller to detect the system voltage automatically on start up.*

*\*\* Array voltage should never exceed maximum PV input voltage. Refer to the solar module documentation to determine the highest expected array Voc (open circuit voltage) as defined by the lowest expected ambient temperature for the system location.*

## 2.3 Characteristics

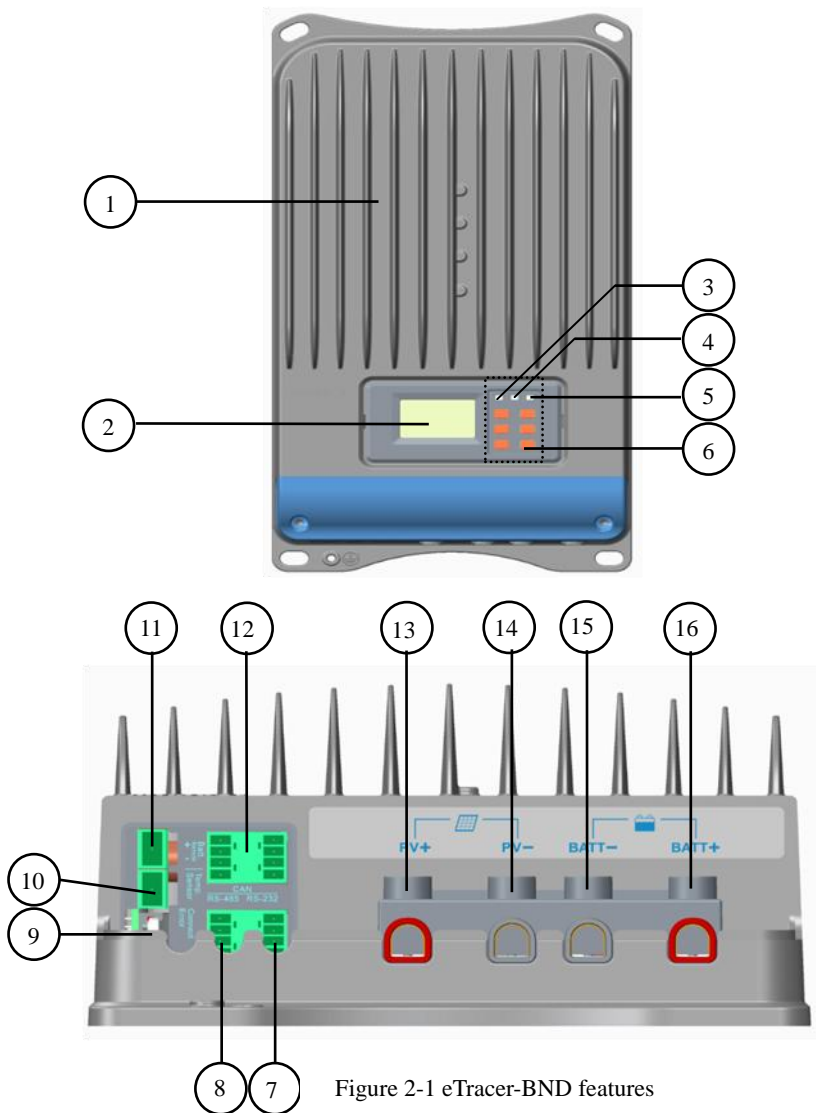

Figure 2-1 eTracer-BND features



### **1 – Heat Sink**

Aluminum heat sink to dissipate controller heat.

### **2 – LCD**

Display the status and data.

### **3 – Battery LED indicator**

Three states of battery LED indicator show charging status.

### **4 – Charging LED indicator**

Indicate that the battery is charging or not.

### **5 – Fault LED indicator**

Indicate that controller faults.

### **6 – Buttons**

Browse or modify all parameters.

### **7 – RS-232 port**

Monitor controller by PC and update controller software.

### **8 – RS-485 port**

Monitor controller by PC and update controller software.

### **9 –RTC battery**

Power to RTC, battery model is CR2032.

### **10 – Remote Temperature Sensor port(MC1.5-5.08-2L)**

Connection for a RTS (Remote Temperature Sensor, optional) to remotely monitor battery temperature.

### **11 – Remote Battery Voltage Sensor port(MC1.5-5.08-2L)**

Connection for RBVS (Remote Battery Voltage Sensor) to provide accurate battery voltage measurement.

### **12 – Reserved Port (MC1.5-3.81-4L)**

Reserved port for future development.

### **13 – Solar Positive Terminal (+)**

Power connection for Solar Positive Terminal.

### **14 –Solar Negative Terminal (-)**

Power connection for Solar Negative Terminal.

**15 –Battery Negative Terminal** ⊖

Power connection for Battery Negative Terminal.

**16 –Battery Positive Terminal** ⊕

Power connection for Battery Positive Terminal.

## 2.4 Accessories

---

### **Remote Temperature Sensor (Model:RTS300R10K5.08A)**

.....

Acquiring of battery temperature for undertaking temperature compensation of control parameters, the standard length of the cable is 3m (length can be customized). The RTS300R10K5.08A connects to the MC1.5-5.08-2L port (10<sup>th</sup>) on the controller.

### **USB To RS-485 Converter(Model:CC-USB-RS485-150U-3.81)**

.....

The USB to RS-485 converter is used to monitor each controller on the network using EPsolar Station PC software and update the firmware. The length of cable is 1.5m. The CC-USB-RS485-150U-3.81 connects to the MC1.5-5.08-2L port (8<sup>th</sup>) on the controller.

## 3 Installation Instructions

### 3.1 General Installation Notes

---

- Read through the entire installation section first before beginning installation.
- Be very careful when working with batteries. Wear eye protection. Have fresh water available to wash and clean any contact with battery acid.
- Use insulated tools and avoid placing metal objects near the batteries.
- Explosive battery gases may be present during charging. So well ventilation of battery box is recommended.
- Avoid direct sunlight and do not install in locations where water can enter the controller.
- Ventilation is highly recommended if mounted in an enclosure. Never install the eTracer-BND in a sealed enclosure with flooded batteries! Battery fumes from vented batteries will corrode and destroy the eTracer-BND circuits.
- Loose power connections and/or corroded wires may result in resistive connections that melt wire insulation, burn surrounding materials, or even cause fire. Ensure tight connections and use cable clamps to secure cables and prevent them from swaying in mobile applications.
- Gel, Sealed or Flooded batteries are recommended, other kinds please refer to the battery manufacturer.
- Battery connection may be wired to one battery or a bank of batteries. The following instructions refer to a singular battery, but it is implied that the battery connection can be made to either one battery or a group of batteries in a battery bank.
- Multiple same models of controllers can be installed in parallel on the same battery bank to achieve higher charging current. Each controller must have its own solar module(s).
- Select the system cables according to  $3.5\text{A}/\text{mm}^2$  or less current density.

## 3.2 Mounting



**NOTE:** The eTracer-BND controller requires at least 150mm of clearance above and below for proper air flow. Ventilation is highly recommended if mounted in an enclosure.



**WARNING:** Risk of explosion! Never install the eTracer-BND in a sealed enclosure with flooded batteries! Do not install in a confined area where battery gas can accumulate.

### Step1: Choose a Mounting Location

Place the eTracer-BND controller on a vertical surface protected from direct sunlight, high temperatures, and water.

### Step2: Check for Clearance

Place the eTracer-BND in the location where it will be mounted. Verify sufficient room to run wires and sufficient room above and below the controller for air flow.

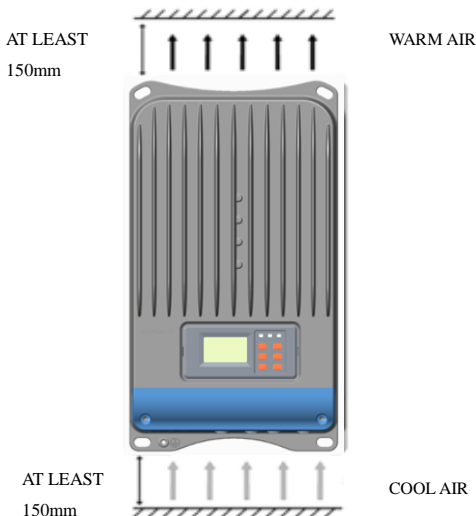

Figure3-1 Required mounting clearance for air

### Step3: Mark Holes

.....  
Mark the four (4) mounting holes locations on the mounting surface.

### Step 4: Drill Holes

.....  
Remove the controller and drill four sizeable holes at the marked locations.

### Step 5: Secure the Controller

.....  
Place the controller on the surface and align the mounting holes with the drilled holes in step 4. Secure the controller in place using the mounting screws.

## 3.3 Wiring

---



**NOTE:** A recommended connection order has been provided for maximum safety during installation.



**NOTE:** Do not entangle all wiring together. Communication cable and power wires should be as far as possible to avoid interfering communication signal transmission.



**NOTE:** The eTracer-BND is a negative ground controller. Any negative connection of solar or battery can be earth grounded as required.



**CAUTION:** For mobile applications, be very certain that all wirings are connected securely. Use cable clamps to prevent cables from swaying when the vehicle is in motion. Unsecured cables create loose and resistive connections which may lead to excessive heating and/or fire.

### Step 1: Remote Temperature Sensor Connection (RTS300R10K5.08A)

.....



**CAUTION:** The controller will perform temperature compensation for charging parameters according to the device temperature.



**CAUTION:** Equipment Damage! Never place the temperature sensor inside a battery. Both the RTS300R10K5.08A and the battery will be damaged.

The included remote temperature sensor RTS300R10K5.08A is recommended for effective temperature compensated charging. Connect the RTS300R10K5.08A to the 10<sup>th</sup> port (MC1.5-5.08-2L) on the controller (see figure 2-1). The cable standard length is 3 meters and could be customized. There is no polarity, so either wire (+ or -)

can be connected to either screw terminal. No damage will result if connect the RTS300R10K5.08A to the remote battery voltage sense port, but the connection will not be recognized.

## Step 2: Remote Battery Voltage Sensor Connection

---



**NOTE:** When connecting Remote Battery Voltage Sensor, please pay attention to ‘+’ and ‘-’ (see figure 2-1).



**CAUTION:** Be careful when installation. Please never plug the voltage sensor wires into to the RTS300R10K5.08A terminals (10<sup>th</sup> Port). This will cause an alarm or damage the controller.

The voltage at the battery terminals on the controller may differ slightly from the real battery voltage due to connection and cable resistance. The remote battery voltage sensor will enable the controller to detect the battery voltage more exactly and avoid voltage deviation. The battery voltage sensor connection is not required to operate the controller, but it is recommended for the best performance.

The voltage sensor wires should be cut into the length as required. The wire size can range from 0.25 to 1.0 mm<sup>2</sup> (24 to 16 AWG). Maximum length is 3m. Connect the remote battery voltage sensor wires to the 11<sup>th</sup> port (MC1.5-5.08-2L) on the controller (see figure 2-1). A twin-cord cable is recommended but not required.

Please be careful to ‘+’ and ‘-’ when connecting. No damage will result if the polarity is reversed, but the controller can’t read a reversed sensor voltage. Plugging the voltage sensor wires into to the RTS300R10K5.08A terminals (10<sup>th</sup> Port) will cause an alarm or damage the controller

### Step 3: Communicate Connection

---



**WARNING:** Shock Hazard! Should not be any communication cables and power lines intertwined. Separate them as far as possible to void electric shock.

There are two kinds of communication: RS-232 and RS-485. Please use matching communication cables and make sure the cables are connected firmly during data transmitting: the below features are supported with communication interface:

Monitor each controller on the network using EPsolar Station PC software; update the firmware;

- **RS-232, RS-485 Connection**

The series port on eTracer-BND controller is a standard 3.81-4P port. See figure 2-1 for the port location. The RS-232 port is 7<sup>th</sup> port and the RS-485 port is 8<sup>th</sup> port on the controller.

### Step 4: Connect the Power Wires

---



**WARNING:** Risk of electric shock! Use fuses or breakers in solar and battery circuits is recommended, and make them keep OFF state before connection.



**WARNING:** Risk of electric shock! Exercise caution when handling solar wiring. The solar PV array can produce open-circuit voltages in excess of 100 Vdc when in sunlight. Pay more attention for it.



**WARNING:** Risk of explosion or fire! Never short circuit battery positive (+) and negative (-) or cables. Pay more attention for it

- **Battery Connection**

Connecting a fuse in series through battery positive (+) in the circuit and the battery circuit fuse must be 1.25 to 2 times of the rated current. Keep OFF before connection.

Connect battery positive (+) and negative (-) to battery terminals on the controller in the figure 2-1. Please pay much attention to ‘+’ and ‘-’.

- **Solar Module(s) Connection**

Connecting a breaker in series in the solar circuit is recommended, and the breaker must be 1.25 to 2 times of the rated current. Keep OFF before connection. Connect solar positive (+) and negative (-) to solar terminals on the controller in the figure 2-1. Please pay much attention to '+' and '-'.

Solar array short circuit protection and the reversed polarity connection will trigger automatically.

#### Step 5: Power-Up

---



**NOTE:** The controller is only powered by battery, so it will not work when only connecting to solar input.

- Confirm that all connections are correct especially the Solar and Battery polarities.
- Turn the battery disconnect switch on first. Observe that the LED's indicate a successful start-up (refer to section 4.0).
- Turn the solar disconnect on. If the solar array is in full sunlight, the charging LED will blink and the controller will begin charging.
- If the battery LED error exists or LCD interface alarms, refer to section 5.0 for troubleshooting.



# 4 Operation

## 4.1 MPPT Technology

---

The eTracer-BND utilizes Maximum Power Point Tracking technology to extract maximum power from the solar array. The tracking algorithm is fully automatic and does not require user adjustment. eTracer-BND technology will track the array maximum power point voltage ( $V_{mp}$ ) as it varies with weather conditions, ensuring that maximum power is harvested from the array through the course of the day.

### Current Boost

In many cases, eTracer-BND MPPT technology will ‘boost’ the solar charge current. For example, a system may have 8 Amps of solar current flowing into the eTracer-BND and 10 Amps of charge current flowing out to the battery. The eTracer-BND does not create current! Rest assured that the power into the eTracer-BND is the same as the power out of the eTracer-BND. Since power is the product of voltage and current (Volts×Amps), the following is true\*:

- (1) Power Into the eTracer-BND =Power Out of the eTracer-BND
- (2) Volts In×Amps In=Volts Out×Amps Out

\* Assuming 100% efficiency. Actually, the losses in wiring and conversion exist.

If the solar module’s  $V_{mp}$  is greater than the battery voltage, it follows that the battery current must be proportionally greater than the solar input current so that input and output power are balanced. The greater the difference between the maximum power voltage and battery voltage, the greater the current boost. Current boost can be substantial in systems where the solar array is of a higher nominal voltage than the battery.

### An Advantage Over Traditional Controllers

Traditional controllers connect the solar module directly to the battery when recharging. This requires that the solar module operate in a voltage range that is below the module’s

$V_{mp}$ . In a 12V system for example, the battery voltage may range from 11 to 15Vdc but the module's  $V_{mp}$  is typically around 16 or 17V.

Figure 4-1 shows a typical current VS. Voltage output curve for a nominal 12V off-grid module.

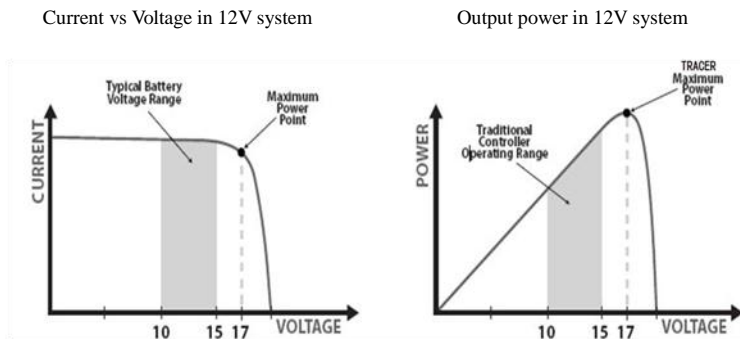

Figure 4-1 Nominal 12V solar module I-V curve and output power graph

The array  $V_{mp}$  is the voltage where the product of current and voltage (Amps  $\times$  Volts) is greatest, which falls on the 'knee' of the solar module I-V curve as shown in Figure 4-1. Because Traditional controllers do not operate at the  $V_{mp}$  of the solar module(s), energy is wasted that could otherwise be used to charge the battery and power system loads. The greater the difference between battery voltage and the  $V_{mp}$  of the module, the more energy is wasted.

eTracer-BND MPPT technology will always operate at the  $V_{mp}$  resulting in less wasted energy compared to traditional controllers.

### Conditions That Limits the Effectiveness of MPPT

The  $V_{mp}$  of a solar module decreases as the temperature of the module increases. In very hot weather, the  $V_{mp}$  may be close or even less than battery voltage. In this situation, there will be very little or no MPPT gain compared to traditional controllers. However, systems with modules of higher nominal voltage than the battery bank will always have

an array  $V_{mp}$  greater than battery voltage. Additionally, the savings in wiring due to reduced solar current make MPPT worthwhile even in hot climates.

## 4.2 Battery Charging Information

---

The eTracer-BND has a 4 stages battery charging algorithm for rapid, efficient, and safe battery charging.



Figura4-2 eTracer-BND charging algorithm

### • Bulk Charge

In this stage, the battery voltage has not yet reached boost voltage and 100% of available solar power is used to recharge the battery.

### • Boost Charge

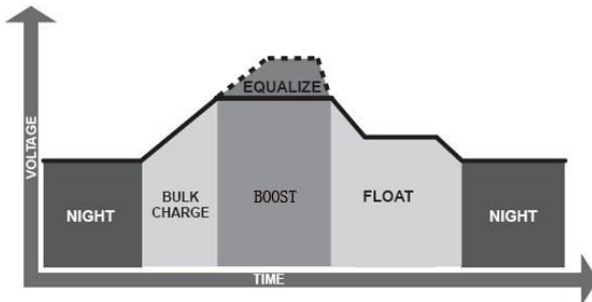
When the battery has recharged to the Boost voltage setpoint, constant-voltage regulation is used to prevent heating and excessive battery gassing. The Boost stage remains for some time and then goes to Float Charge. Every time when the controller is powered on, if it detects not overvoltage, the charging will enter into boost charging stage.

### • Float Charge

After the Boost voltage stage, eTracer-BND will reduce the battery voltage to float voltage setpoint. When the battery is fully recharged, there will be no more chemical reactions and all the charge current transmits into heat and gas at this time. Then the eTracer-BND reduces the voltage to the floating stage, charging with a smaller voltage

and current. It will reduce the temperature of battery and prevent the gassing and charge the battery slightly at the same time. The purpose of Float stage is to offset the power consumption caused by self consumption, while maintaining full battery storage capacity.

Once in Float stage, should the battery voltage remain below the Boost Return Voltage; the controller will exit Float stage and return to Bulk charging.

- **Equalize**



**WARNING:** Risk of explosion!

Equalizing flooded battery would produce explosive gases, so well ventilation of battery box is recommended.



**NOTE:** Equipment damage!

Over-charging and excessive gas precipitation may damage the battery plates and activate material shedding on them. Too high and equalizing charge or for too long may cause damage. Please carefully review the specific requirements of the battery used in the system.

Certain types of batteries benefit from periodic equalizing charge, which can stir the electrolyte, balance battery voltage and complete chemical reaction. Equalizing charge increases the battery voltage, higher than the standard complement voltage, which gasifies the battery electrolyte.

The controller will equalize the battery on 28<sup>th</sup> each month. The constant equalization period is 0~180 minutes. If the equalization isn't accomplished in one-time, the equalization recharge time will be accumulated until the set time is finished. Equalize charge and boost charge are not carried out constantly in a full charge process to avoid too much gas precipitation or overheating of battery.

NOTE: When the sunshine is weak and Charging current is less than 1.5Amps, the controller couldn't fully follow the maximum power tracking. Therefore, don't evaluate in that condition.

## 4.3 LED Indication

---



### Charging LED

---

Indicator	Status
Green Blink	Charging
Green OFF	No charging



### Battery LED

---

Indicator	Status
Green ON	Normal
Green slow blink	Full
Orange ON	Under voltage warning
Red ON	Low voltage disconnect
Red Blink	Battery over temperature
Green fast blink	High volt disconnect



### Fault LED

---

Indicator	Status
Red OFF	Normal
Red Blink	Current abnormal
	Charging overcurrent
	PV overvoltage

### All Indicator

---

Indicator	Fault Status
Blink (Battery LED in Red)	Work voltage error
Blink (Battery LED in Orange)	Controller over temperature

## 4.4 LCD Display & Operation

---

### ➤ Initialization

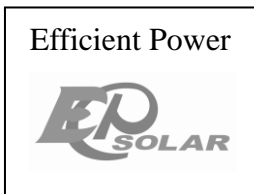

LCD will paint the picture as shown on the left as soon as it is powered on. It indicates that initialization is normal when the interface goes automatically to the Rated Info interface.

### ➤ Rated Info

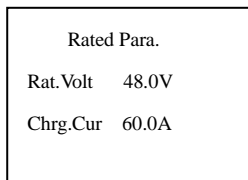

Rated info of the controller will be displayed. Monitor interface will be switched after 3 seconds.

### ➤ Main Menu

Click **ESC** button to return main menu in any monitoring interface.

There are 9 interfaces for monitoring, as shown in the below picture.

Press **↑** **↓** button to move inverse cursor among 8 menus.

Press **OK** to enter corresponding interface.

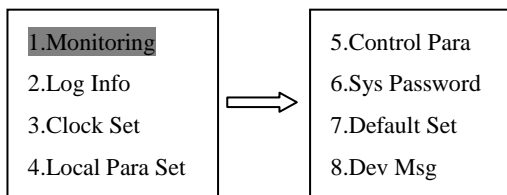

## ➤ Monitor

There are 9 interfaces for monitoring, as shown below:

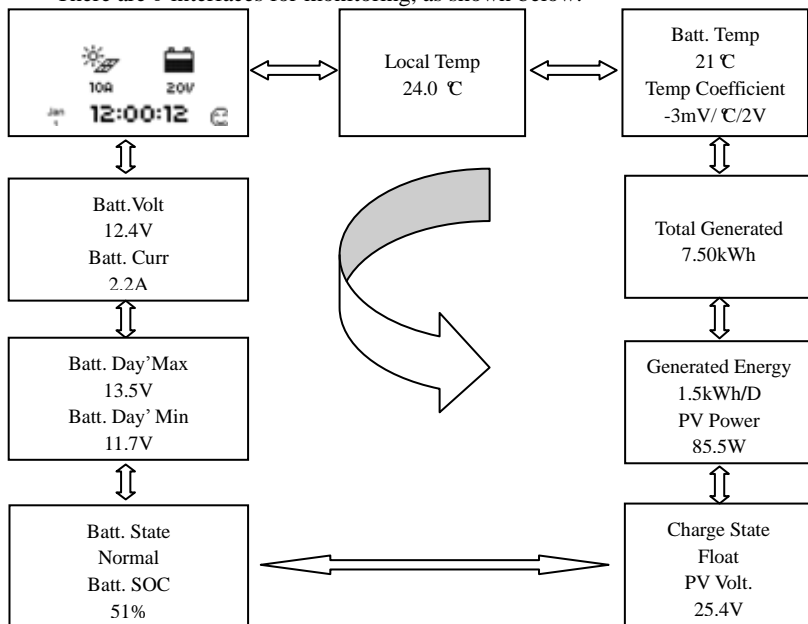

Press **OK** to enter the monitoring interface when the inverse cursor point to **monitor** item.

The parameters in monitoring interface are only for browse.

Press **↑** **↓** button to browse the parameters interfaces in turns. There are 5 battery status: Normal, UVW(Under voltage warning), LVD(Low voltage disconnect), Over Voltage, Over Temperature and 4 charging stages: no charging, equalized, boost, float.

## Log Info

There are two items of log record as shown below.

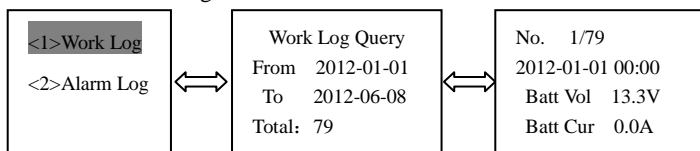

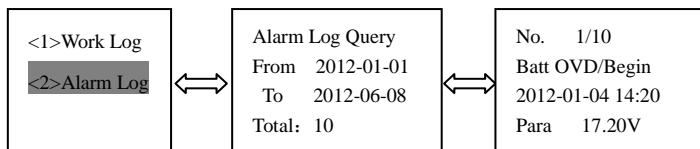

Press **OK** to enter the monitoring interface when the inverse cursor point to **monitor** item. Press **ESC** button to exit. Work Log and Event Log could be browsed in this interface, the operation is as follows:

Press **OK** to enter the **Work Log** or **Event Log** interface respectively when the item is chosen in inverse. Press **OK** again to enter the Edit Mode. Use **↑** or **↓** button to move the cursor between the time parameters and data bit. Use **+** **-** button to modify the value and set the period of log for browse. When the period is set, press **OK** to enter the corresponding details.

Log Number, time, the voltage and current of battery are included in every work log item and are shown in the Work Log interface.

warning event sequence number, warning event, start or end time, the fault status and values are all included in every event log item and are shown in the Event Log interface.

### ➤ **Clock Set**

The interface of Clock Set is shown as follow:

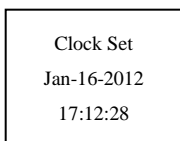

Press **OK** to enter the Clock Set interface when the inverse cursor point to **Clock Set** item. Press **ESC** button to exit.

Date and Time can be adjusted in this interface. Press **OK** and input the 6 digit user password and then Date and Time could be adjusted. The format of date is YYYY-MM-DD; the one of time is HH-MM-SS. When the set is over, press **OK** to save or press **ESC** button to cancel. “Save success!” will be promoted if adjusted and save operated successfully.

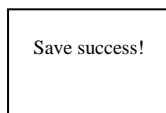
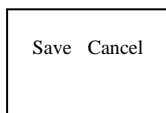
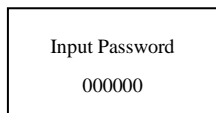



**NOTE:** The log after the current time will be erased when the clock has be adjusted.

➤ **Device Parameter**

There are 3 interfaces about device parameter as shown blew:

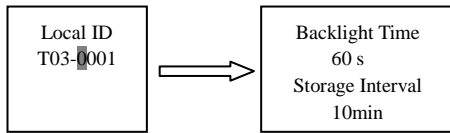

Press **OK** to enter the Device Parameter interface when the inverse cursor point to **Device Para** item. Press **ESC** button to exit.

You should input the user password (see above) before setting the parameters.

The first interface shows the 4-digit controller's ID in networking and keeps the ID number unique in the networking or PC software or other device(s) couldn't search it.

The 2<sup>nd</sup> interface shows the backlight time. The range is from 1 to 90 seconds (60seconds default). “-” means that the backlight is never off. The interval log is from 1 to 30 minutes (10minutes default).

➤ **Control Parameter**

Press **OK** to enter the Device Parameter interface when the inverse cursor point to **Control Para** item. Press **ESC** button to exit. There are 10 interfaces for ‘Control Parameters’ as shown below.

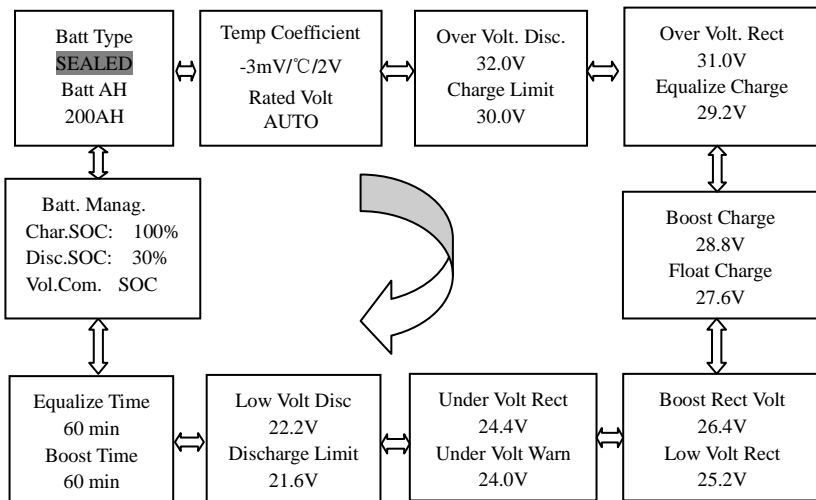

You should input the user password(see above) before setting the parameters. In setting mode, all the parameters can be modified. And will immediately effect when saved. The detail and value range of control parameter are shown in the tables below:

### Battery Charging Setting

Battery Type	Note
Sealed (default)	Constant value
GEL	Constant value
flooded	Constant value
User	Defined by user

### Battery Charging Mode

Charging Mode	Note
Voltage Compensate	Controlled by voltage(default)
SOC	SOC mode, controlled by SOC charging or discharging value

## Others

Parameter	Default value	Range
Battery capacity	200Ah	1~9999Ah
Temperature compensate coefficient	-3mV/ °C/2V	-9~0 mV/ °C/2V
Rated system voltage	Auto	12/24/36/48VDC Auto
Percent of charging	100%	100% constant value(SOC charging mode)
Percent of discharging	30%	10~80% (SOC charging mode)

## Battery Control Parameters

All the coefficient is referred to 25°C, and twice in 24V system rate, triple in 36Vsystem rate and quadruple in 48Vsystem rate.

Battery Type	Gel	Sealed	Flooded	User
High Volt Disconnect	16V	16V	16V	9~17V
Charging limit voltage	15V	15V	15V	9~17V
Over Voltage Reconnect	15V	15V	15V	9~17V
Equalization voltage	14.6V	——	14.8V	9~17V
Boost voltage	14.4V	14.2V	14.6V	9~17V
Float voltage	13.8V	13.8V	13.8V	9~17V
Boost return voltage	13.2V	13.2V	13.2V	9~17V
Low voltage reconnect	12.6V	12.6V	12.6V	9~17V
Under voltage recover	12.2V	12.2V	12.2V	9~17V
Under voltage warning	12V	12V	12V	9~17V
Low voltage disconnect	11.1V	11.1V	11.1V	9~17V
Discharging limits voltage	10.6V	10.6V	10.6V	9~17V
Equalize duration	120min	——	120min	0~180min
Boost duration	120min	120min	120min	10~180min

Note: 1. When the battery type is sealed, gel, flooded, the adjusting range of equalize duration is 0 to180min and boost duration is 10 to180min.

2. The following rules must be observed when modify the parameters value in user battery type (factory default value is the same as sealed type):

Rule1: High Volt Disconnect > Charging limit voltage ≥ Equalization voltage ≥ Boost voltage ≥ Float voltage > Boost return voltage;

Rule2: High Volt Disconnect > Over Voltage Reconnect;

Rule3: Low voltage reconnect > Low voltage disconnect ≥ Charging limit voltage;

Rule4: Under voltage recover > Under voltage warning ≥ Charging limit voltage;

Rule5: Boost return voltage > Low voltage reconnect;

➤ **Password**

Press **OK** to enter the **Password Set** interface when the inverse cursor points to **Password Para** item. Press **ESC** button to exit.

```
Sys Password
Old PSW 000000
New PSW 000000
```

Note: The factory default password is “000000” .

➤ **Default Set**

Under the main menu interface, when the inverse cursor to restore the default option, press the **OK** button to enter to restore the default interface.

```
Default Set
No      Yes
Clr Log Record
Retain  clear
```

Under the main menu interface, when the inverse cursor points to restore the default option, press the **OK** button to enter to restore the default interface and clear all logs including work log and event log. Note: all parameters will be set to factory default and couldn't be recovery.

➤ **Device Message**

Under the main menu interface, when the inverse cursor to the **Dev Msg**, press the **OK** button to enter to Device Info interface.

```
ARM Msg.
Type: ET6415BND
Ver:V02.05+V02.60
SN:0420131210000001
```



```
DSP Msg.
Type: ET6415BND
Ver:V02.05+V02.60
SN: 0420131210000001
```

The Model, software and hardware version and SN number are shown in this interface.

# 5 Protections, Troubleshooting & Maintenance

## 5.1 Protections

---

- **PV Short Circuit**

When PV short circuit occurs, the controller will stop charging. Clear it to resume normal operation.

- **PV Over Voltage**

If PV voltage is larger than maximum input open voltage 150V, PV will remain disconnected and warning until the voltage falls safely below 145V. PV voltage cannot be too high, otherwise it may damage the controller, please verify the PV parameter.

- **PV Over Current**

The eTracer-BND controller will limit battery current to the Maximum Battery Current rating. An over-sized solar array will not operate at peak power.

- **PV or/and Battery Polarity Reversed**

Fully protection against PV or/and Battery reverse polarity, no damage to the controller will result. Correct the miswire to resume normal operation.

- **Over Temperature Protection**

If the temperature of the controller heat sinks exceeds 85 °C, the controller will automatically start the overheating protection and recover below 75 °C.



**NOTE: Faults will be cleared every day, so the faults which aren't caused by hardware can be solved intelligently.**

## 5.2 Troubleshooting

---



Charging LED indicator off during daytime when sunshine falls on solar modules properly

Solution: Confirm that PV and battery wire connections are correct and tight.  
.....



Battery LED indicator green fast blink and LCD displaying 'OVD'

Probable Cause: Battery voltage is larger than over voltage disconnect voltage (OVD).

Solution: Check if battery voltage too high, and disconnect solar modules.  
.....

❓ Fault LED indicator blink, LCD displaying ‘Current Err’

Probable Cause: Charging current in three phases is unbalanced.

Solution: Disconnect solar modules and restart the eTracer-BND; if the fault still exists, please contact the supplier to make maintenance.

.....

❓ Fault LED indicator blink, LCD displaying ‘Over Volt’

Probable Cause: solar modular output is too high.

Solution: Check solar component parameters matching; the controller will disconnect the input if the voltage is over 150V and will Recovery below 145V.

.....

❓ Fault LED indicator blink, LCD displaying ‘Over Temp’

Probable Cause: Heat sinks operational temperature is quite high to 85 °C or above.

Solution: The controller will automatically stop working. When the temperature is below 75 °C, the controller will resume to work.

.....

❓ Cannot connect to the controller via RS-485 or RS-232

Probable Cause: RS-485 serial baud rate setting error or serial-USB adapter incorrect configuration.

Solution: Check serial baud rate is set to 115200bps or not and choose the right COM port; If using a serial-USB adapter, verify that the adapter software is installed and a serial COM port has been mapped.

### **5.3 Maintenance**

---

The following inspections and maintenance tasks are recommended at least two times per year for best controller performance.

- Check that the controller is securely mounted in a clean and dry environment.
- Check that the air flow and ventilation around the controller is not blocked. Clear all dirt or fragments on the heat sink.
- Check all the naked wires to make sure insulation is not damaged for serious solarization, frictional wear, dryness, insects or rats etc. Maintain or replace the wires if necessary.
- Tighten all the terminals. Inspect for loose, broken, or burnt wire connections.

- Check and confirm that LED or LCD is consistent with required. Pay attention to any troubleshooting or error indication .Take necessary corrective action.
- Confirm that all the system components are ground connected tightly and correctly.
- Confirm that all the terminals have no corrosion, insulation damaged, high temperature or burnt/discolored sign, tighten terminal screws to the suggested torque.
- Inspect for dirt, insects and corrosion, and clear up.
- Check and confirm that lightning arrester is in good condition. Replace a new one in time to avoid damaging of the controller and even other equipments.



**Warning: Risk of electric shock!**

**Make sure that all the power is turned off before above operations, and then follow the corresponding inspections and operations.**

## 6 PC Software

The eTracer-BND controller can be connected to a common PC monitoring software by supporting USB communication cable developed by the EPSolar company. Monitoring software can remote single or more controllers to modify the parameters and others in the PV system management (username: administrator, password: 111111 as default). See the specific instructions related software user guide. Software interfaces are shown below:

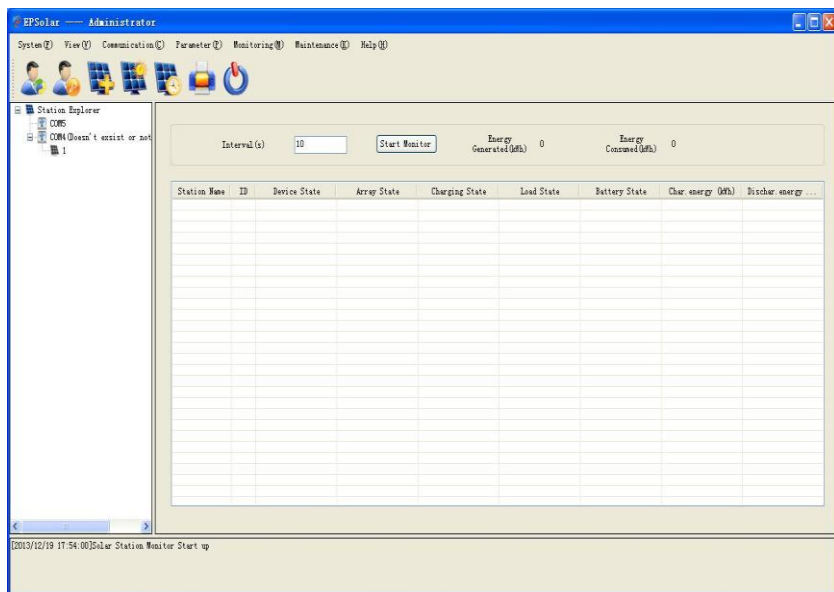

Figure6-1 Globe Monitoring



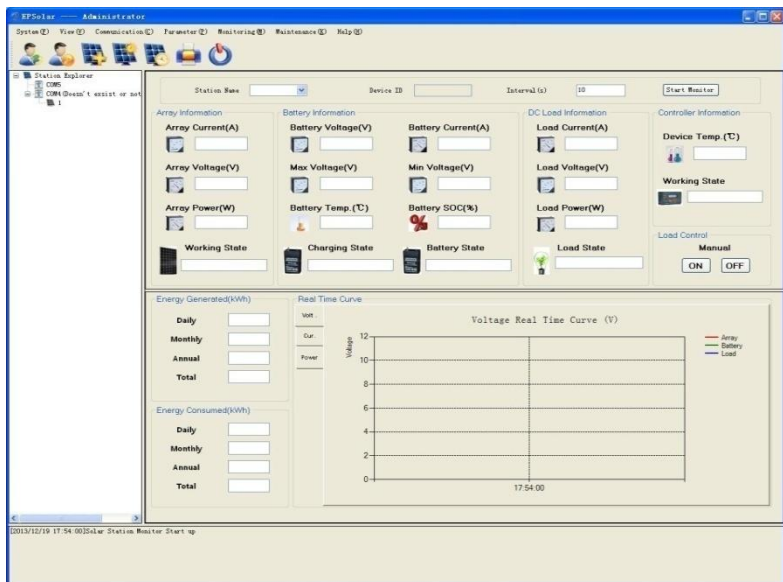

Figure6-2 Real Time Monitoring

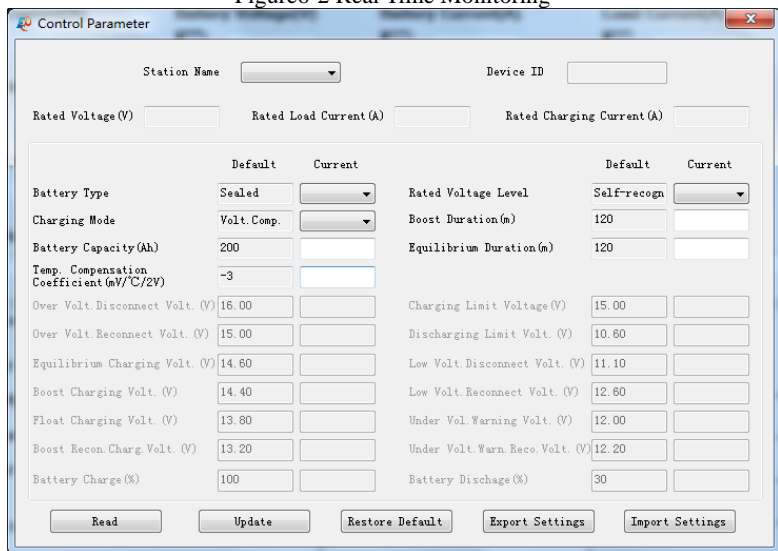

Figure6-3 Control Parameter

## 7 Warranty

The eTracer-BND charge controller is warranted to be free from defects for a period of TWO (2) years from the date of shipment to the original end user.

### • Claim Procedure

.....  
Before requesting warranty service, check the operation manual to be certain that there is a problem with the controller. Return the defective product to us with shipping charges prepaid if problem cannot be solved. Provide proof of date and place of purchase. To obtain rapid service under this warranty, the returned products must include the model, serial number and detailed reason for the failure, the module type and size, type of batteries. This information is critical to a rapid disposition of your warranty claim.

If the products failure is caused by customers' misuse or not following the manual, EPsolar won't be responsible for the free maintenance. We will ask for the raw material cost. And please refer to above procedure.

# 8 Specifications

## Electrical Parameters

---

	<u>ET4415BND</u>	<u>ET6415BND</u>
Nominal System Voltage	12/24/36/48VDC Auto	
Nominal Battery Current	45A	60A
Maximum Solar Input Voltage	150V	
Battery Voltage Range	8~72V	
Maximum Input Power		
12V:	600W	800W
24V:	1200W	1600W
36V:	1800W	2400W
48V:	2400 W	3200W
Self Consumption	1.4~2.2W	
Grounding	Common Negative Grounding	

## Mechanical Parameters

---

	<u>ET4415BND</u>	<u>ET6415BND</u>
L x W x H		
L:	398.6(15.7)mm(inch)	449.1(17.7)mm(inch)
W:	208(8.2)mm(inch)	208(8.2)mm(inch)
H:	107(4.2)mm(inch)	107(4.2)mm(inch)
Net Weight:	4.3kg	5.5kg
Terminal:	35mm <sup>2</sup>	35mm <sup>2</sup>
Mounting Hole:	Φ10	

## Environmental Parameters

---

LCD Temp	-20°C ~ +70°C
Ambient Temp	-25°C ~ +55°C
Storage Temp	-30°C ~ +85°C
Humidity	≤95%, N.C.
Enclosure	IP20

## Protection

---

Solar input short protection

Solar input reversed polarity protection

Solar input reverse current protect at night

Battery reversed polarity protection

Battery over voltage disconnect protection

Battery over voltage reconnect protection

Battery over temperature disconnect protection

Controller over temperature disconnect protection

## Abbreviation

---

**HVD** High voltage disconnect

**LVD** Low voltage disconnect

**OVT** over temperature

**UVW** Under voltage warning

# 9 Conversion Efficiency Curves

Illumination Intensity: 1000W/m<sup>2</sup>

Temperature: 25°C

Test model: ET4415BND

## 1. Solar MPPT Voltage(66V, 98V, 115V) / System Voltage(12V)

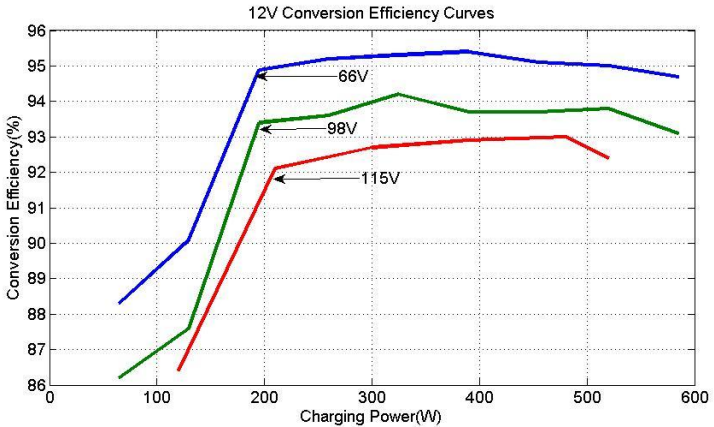

## 2. Solar MPPT Voltage(33V, 66V, 98V, 115V) / System Voltage(24V)

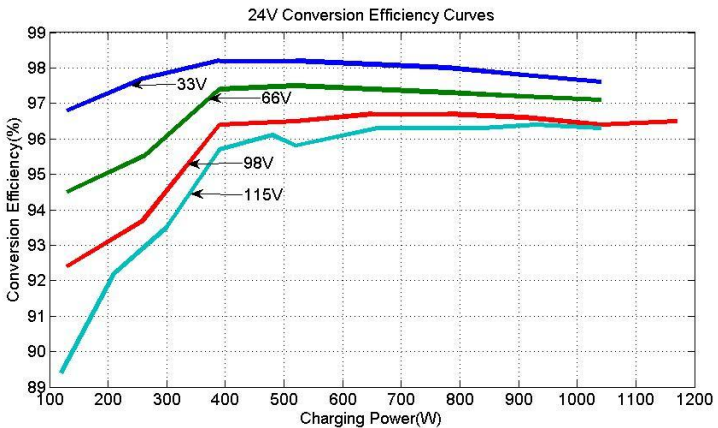

3. Solar MPPT Voltage(66V, 98V, 115V) / System Voltage(36V)

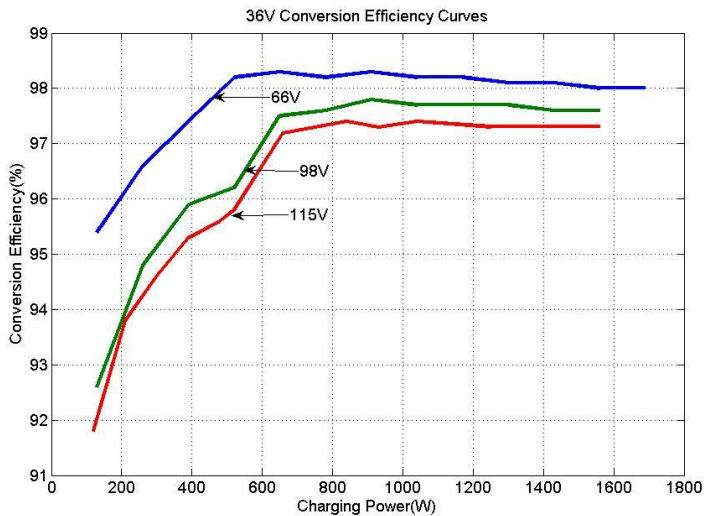

4. Solar MPPT Voltage(66V, 98V, 115V) / System Voltage(48V)

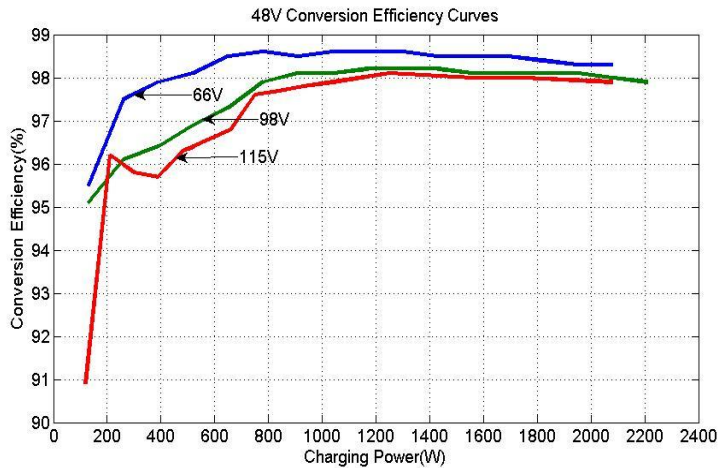

Test model: ET6415BND

1. Solar MPPT Voltage(17V,34V,68V) / System Voltage(12V)

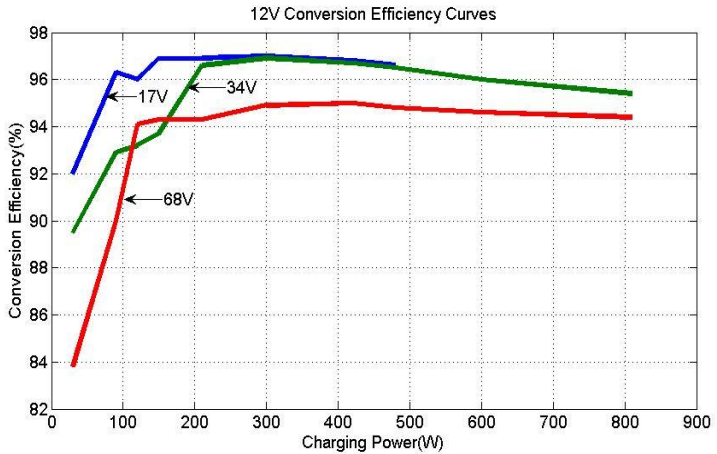

2. Solar MPPT Voltage(34V,68V,115V) / System Voltage(24V)

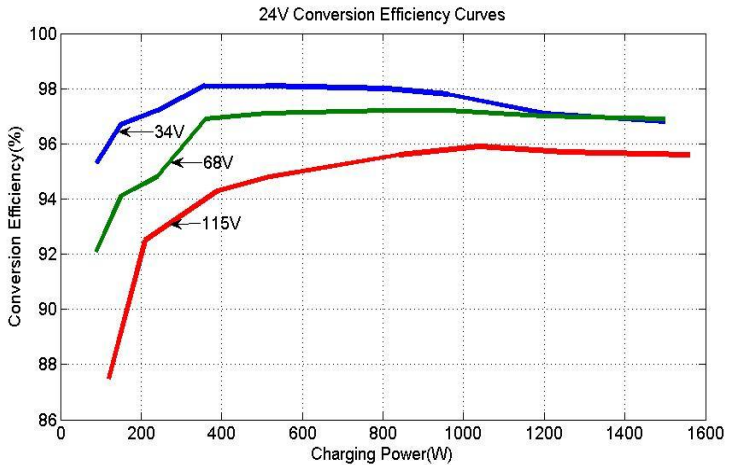

3. Solar MPPT Voltage(68V,115V) / System Voltage(36V)

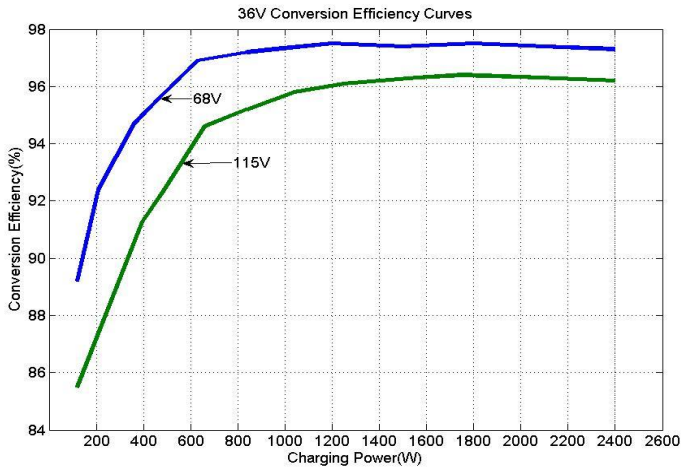

4. Solar MPPT Voltage(68V,115V) / System Voltage(48V)

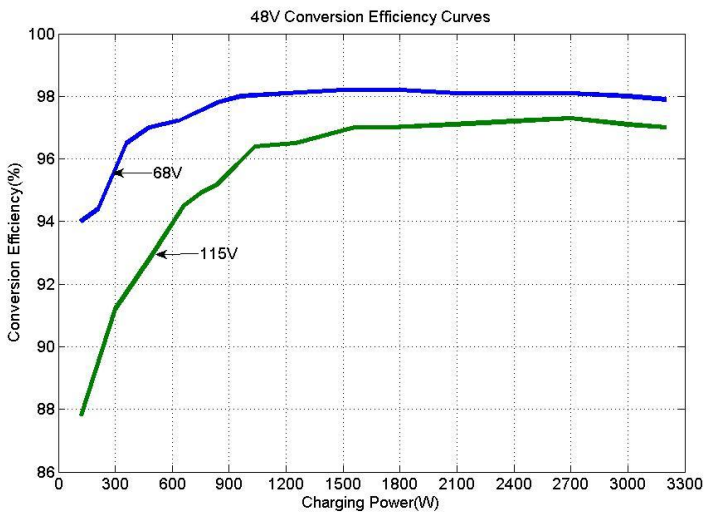



# 10 Dimensions

ET4415BND Dimensions (Unit: mm)

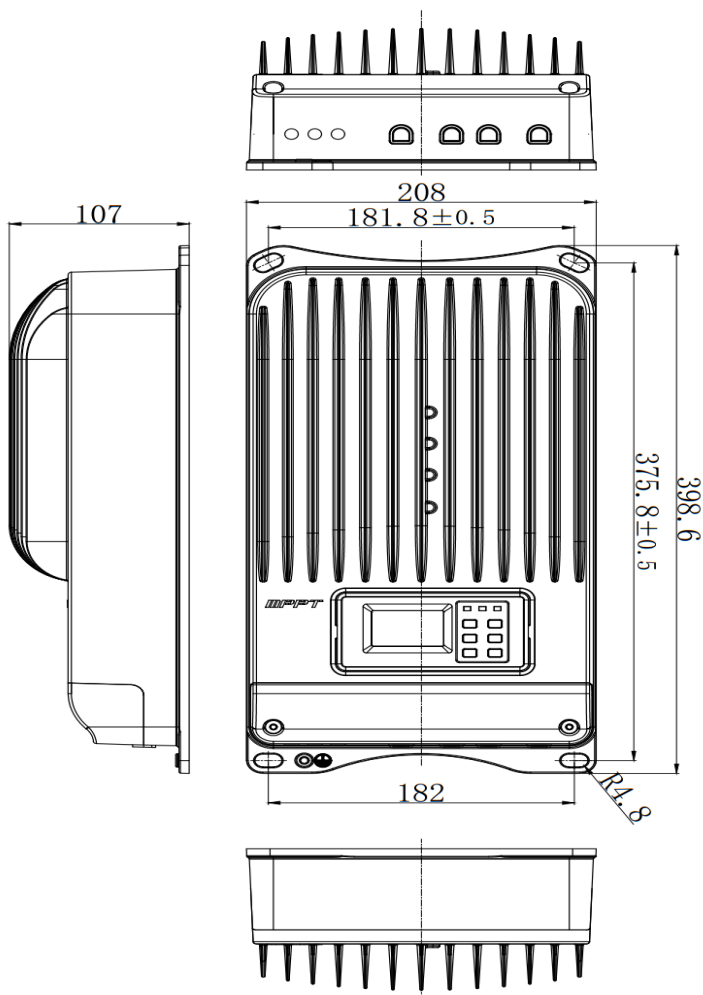

ET6415BND Dimensions (Unit: mm)

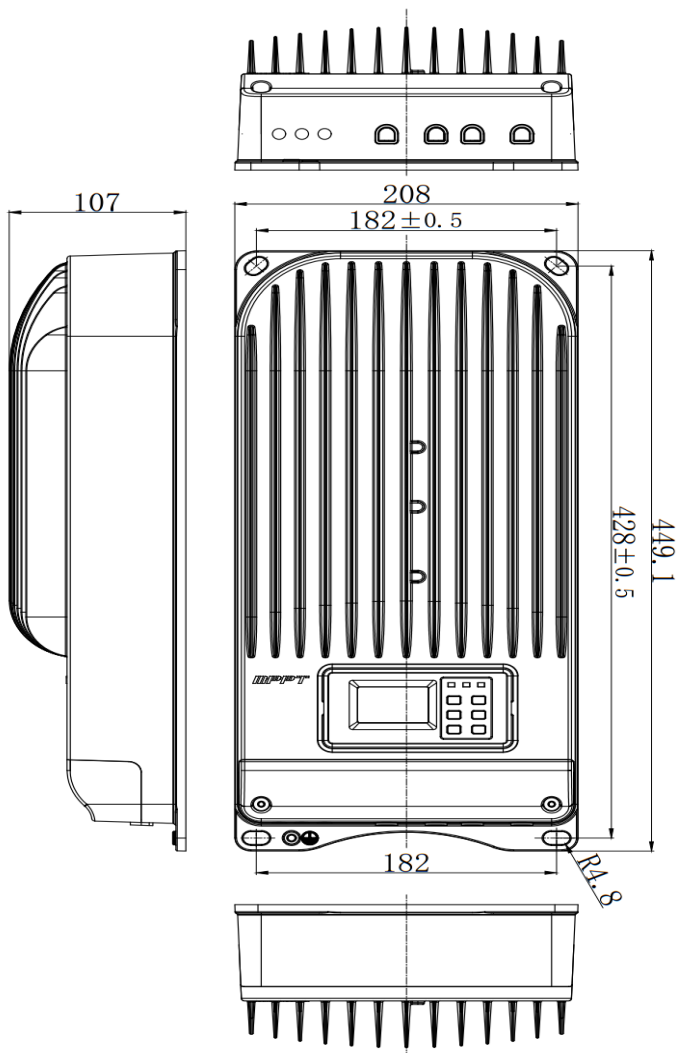

Version: V1.4





**BEIJING EPSOLAR TECHNOLOGY CO., LTD.**

**Tel: +86-10-82894112 / 82894962**

**Fax: +86-10-82894882**

**E-mail: [info@epsolarpv.com](mailto:info@epsolarpv.com)**

**Website: <http://www.epsolarpv.com/>**

